

Product datasheet

Specifications



safety controller XPS-MC - 24 V DC - 16 input - 32 LEDs signalling

XPSMC16ZC

Main

Range Of Product	Preventa Safety automation
Product Or Component Type	Configurable safety controller
Safety Module Name	XPSMC
Safety Use Category	Category 4 maximum conforming to EN 954-1/EN/ISO 13849-1 PLE maximum conforming to ISO 13849-1 SIL 3 maximum conforming to IEC 61508
Type Of Start	Configurable
Standards	IEC 61496-1 EN 574/ISO 13851 EN 1760-1/ISO 13856-1 IEC 61508 EN 954-1/EN/ISO 13849-1 IEC 60947-5-1 IEC 60204-1
Product Certifications	UL TÜV CSA
[Us] Rated Supply Voltage	24 V DC - 20...20 %
Number Of Inputs	16
Communication Port Protocol	CANopen with 1 SUB-D 9-pin male port(s), serial link, transmission rate: 20 kbps, 50 kbps, 125 kbps, 250 kbps, 500 kbps, 800 kbps or 1 Mbps Modbus with 1 RJ45 port(s), serial link, transmission rate: 1200 bps, 2400 bps, 4800 bps, 9600 bps or 19200 bps
Safety Level	Can reach PL e/category 4 conforming to EN 954-1/EN/ISO 13849-1 Can reach SIL 3 conforming to IEC 61508

Complementary

Function Of Module	Dynamic monitoring of hydraulic valves on linear presses Eccentric press Emergency stop monitoring, with or without time delay, 1 or 2-channel wiring Enabling switch monitoring, 2 or 3 contacts Foot switch monitoring Guard monitoring for injection presses and blowing machines Guard monitoring with 1 or 2 limit switches Hydraulic press Magnetic switch monitoring category 4 conforming to EN/IEC 61496 Monitoring safety stop at top dead centre on eccentric press category 3 conforming to EN 574/ISO 13851 Muting function of light curtains Position selector Safety mat monitoring Safety time delays Shaft/chain breaking monitor Zero speed detection Light curtain monitoring category 4 conforming to IEC 61496 Two-hand control category 3 conforming to EN 574/ISO 13851
Synchronisation Time Between Inputs	Depending on configuration selected

Power Consumption In W	12 W
Input Protection Type	External fuse 16 A
[Uc] Control Circuit Voltage	28.8 V
Maximum Line Resistance	100 Ohm <2000 m
Output Type	2 relays, 2 NO contacts (4 NO total) circuit(s) Solid state, 6 circuit(s), volt-free
Breaking Capacity	180 VA holding AC-15 C300 relay output 1800 VA inrush AC-15 C300 relay output
Breaking Capacity	2 A at 24 V for static output circuit 1.5 A at 24 V (DC-13) time constant: 50 ms for relay output
Output Thermal Current	4 A for both outputs simultaneously 6 A for 1 output and 2 A for the other for relay output
[Ith] Conventional Free Air Thermal Current	16 A for relay output 6.5 A for static output circuit
Associated Fuse Rating	16 A gL for power supply 4 A gL for relay output 6 A fast blow for relay output
Minimum Output Current	10 mA for relay output
Minimum Output Voltage	17 V for relay output
Response Time	Configurable : 20 ms or 30 ms with software XPSMCWIN
[Uij] Rated Insulation Voltage	300 V (pollution degree 2) conforming to IEC 60647-5-1, DIN VDE 0110 part 1
[Uimp] Rated Impulse Withstand Voltage	4 kV overvoltage category III conforming to IEC 60647-5-1, DIN VDE 0110 part 1
Method Of Access	Slave
Exchange Size	14 words
Number Of Addresses	1...127 for CANopen 1...247 for Modbus
Parity	Even for Modbus No for Modbus Odd for Modbus
Data Format	1 start bit/8 data bits 1 stop bit even or odd 2 stop bits without parity RTU (Remote Terminal Unit) mode
Supported Modbus Function	01: 8-bit output data/32-bit input data 02: 32-bit input data/8-bit output data 03: information and errors
Local Signalling	32 LEDs
Mounting Support	Mounting plate
Depth	153 mm
Height	151.5 mm
Width	74 mm
Net Weight	0.82 kg

Environment

Ip Degree Of Protection	IP20 conforming to IEC 60529
Ambient Air Temperature For Operation	-10...55 °C
Ambient Air Temperature For Storage	-25...85 °C

Packing Units

Unit Type Of Package 1	PCE
Number Of Units In Package 1	1
Package 1 Height	9.500 cm
Package 1 Width	18.000 cm
Package 1 Length	26.000 cm
Package 1 Weight	1.265 kg
Unit Type Of Package 2	S04
Number Of Units In Package 2	6
Package 2 Height	30.000 cm
Package 2 Width	40.000 cm
Package 2 Length	60.000 cm
Package 2 Weight	8.459 kg

Contractual warranty

Warranty	18 months
----------	-----------

Sustainability

Green Premium™ label is Schneider Electric's commitment to delivering products with best-in-class environmental performance. Green Premium promises compliance with the latest regulations, transparency on environmental impacts, as well as circular and low-CO₂ products.

Guide to assessing product sustainability is a white paper that clarifies global eco-label standards and how to interpret environmental declarations.

[Learn more about Green Premium >](#)

[Guide to assess a product's sustainability >](#)



Transparency RoHS/REACH

Well-being performance

Mercury Free

Rohs Exemption Information Yes

Pvc Free

Certifications & Standards

Reach Regulation

[REACH Declaration](#)

Eu Rohs Directive

Pro-active compliance (Product out of EU RoHS legal scope)

China Rohs Regulation

[China RoHS declaration](#)

Environmental Disclosure

[Product Environmental Profile](#)

Weee

The product must be disposed on European Union markets following specific waste collection and never end up in rubbish bins

Circularity Profile

[End of Life Information](#)

Dimensions

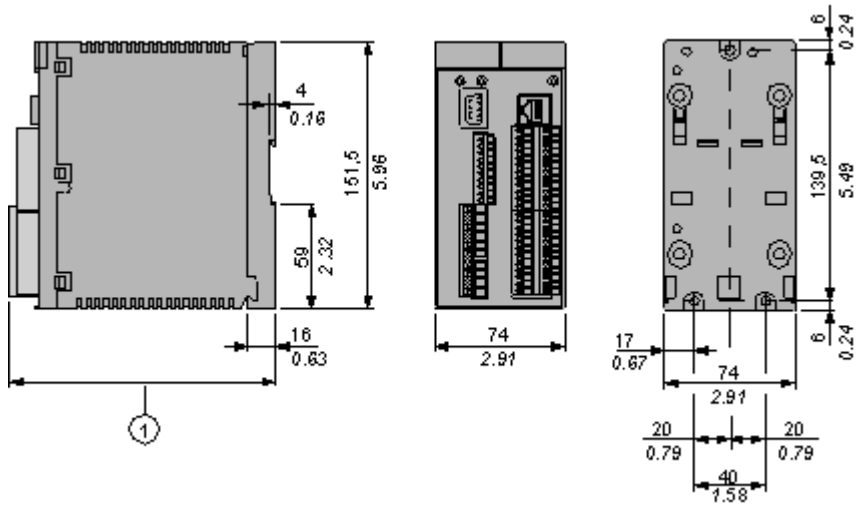

- 1 When using XPSMCTS• connectors this dimension is 153 mm (6.02 in)
When using XPSMCTC• connectors this dimension is 151,5 mm (5.96 in)

Installation

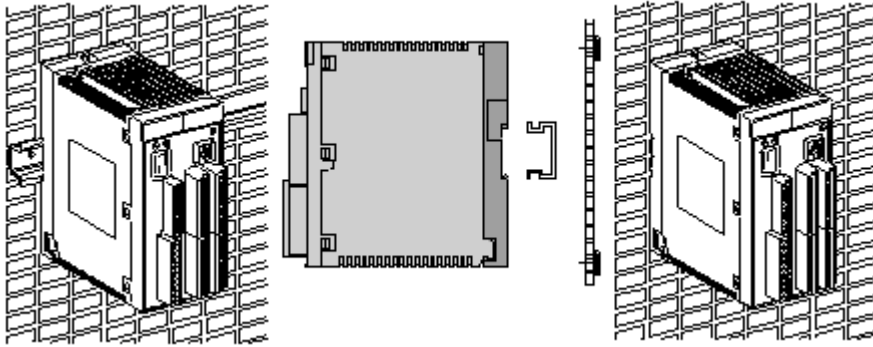

Metal adaptor for fixing on metal: DIN rail 35 mm/1.38 in.

Wiring Diagrams

Refer to the Instruction Sheet

To download the instruction sheet, follow below procedure:



XPSAC5121
module XPSAC - Emergency stop - 24 V AC DC
[Download XPSAC5121 product datasheet](#)

- Discover XPSAC5121 by
- Characteristics
 - Dimensions Drawings
 - Connections and Schema
 - Technical Description
 - **Download & Documents**

Download & Documents 1 to 3 of 3 (Total: -1)

Instruction sheet		
XPSAC... Safety module for emergency stop and switch monitoring	English 2012-07-04	pdf (29)

Image of product		
Emergency stop and switch monitoring	2010-11-10	{Select :}



Certificate		
Russian certificate	English 2010-07-07	pdf (60)



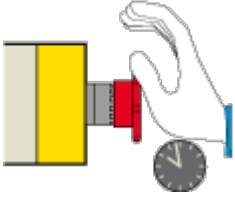
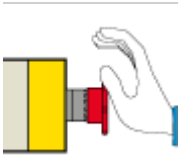
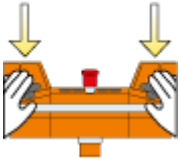
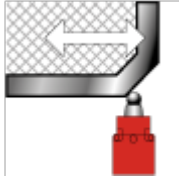

1

2

- 1 Click on **Download & Documents**.
- 2 Click on **Instruction sheet**.

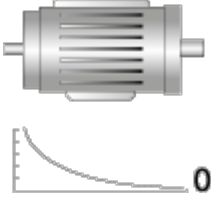
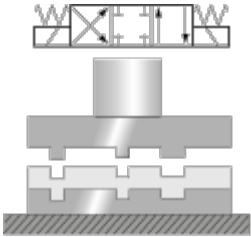
Safety Functions

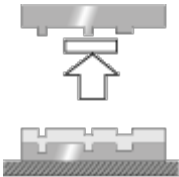
	<ul style="list-style-type: none"> ● Emergency stop monitoring with time delay: <ul style="list-style-type: none"> ○ 1 channel wiring, with automatic start. ○ 2 channel wiring, with start button.
	<ul style="list-style-type: none"> ● Emergency stop monitoring without time delay: <ul style="list-style-type: none"> ○ 1 channel wiring, with automatic start. ○ 2 channel wiring, with start button.
	<ul style="list-style-type: none"> ● Two-hand control.
	<ul style="list-style-type: none"> ● Guard monitoring: <ul style="list-style-type: none"> ○ with 1 limit switch. ○ with 2 limit switches. ○ with 2 limit switches, with guard locking. ● Guard monitoring for injection presses and blowing machines.
	<ul style="list-style-type: none"> ● Magnetic switch monitoring.
	<ul style="list-style-type: none"> ● Sensing mat monitoring.

 <p>A diagram showing a hand reaching towards a set of horizontal red lines between two vertical red bars, representing light curtains.</p>	<ul style="list-style-type: none"> • Light curtains monitoring: <ul style="list-style-type: none"> ◦ Relay output type. ◦ Solid-state output type. • "Muting" function for light curtains.
 <p>A diagram of a motor and a graph showing a speed curve that decays to zero, with a '0' at the end of the curve.</p>	<ul style="list-style-type: none"> • Zero speed detection.
 <p>A cross-sectional diagram of a hydraulic press with a piston and valve assembly, illustrating dynamic monitoring.</p>	<ul style="list-style-type: none"> • Dynamic monitoring of hydraulic valves on linear presses.
 <p>A diagram showing a hand holding a tool near a rotating gear, with a clock icon indicating time delays.</p>	<ul style="list-style-type: none"> • Safety time delays.
 <p>A diagram of an eccentric press mechanism with a piston and a downward-pointing arrow, illustrating safety stop monitoring.</p>	<ul style="list-style-type: none"> • Monitoring safety stop at top dead centre on eccentric press. • Hydraulic press. • Eccentric press.
 <p>A diagram showing a hand holding a black cylindrical component, representing enabling switching monitoring.</p>	<ul style="list-style-type: none"> • Enabling switching monitoring: <ul style="list-style-type: none"> ◦ 2 contact type. ◦ 3 contact type.

Other functions:

- Foot switch monitoring
- Chain shaft breakage monitoring
- Position selector